

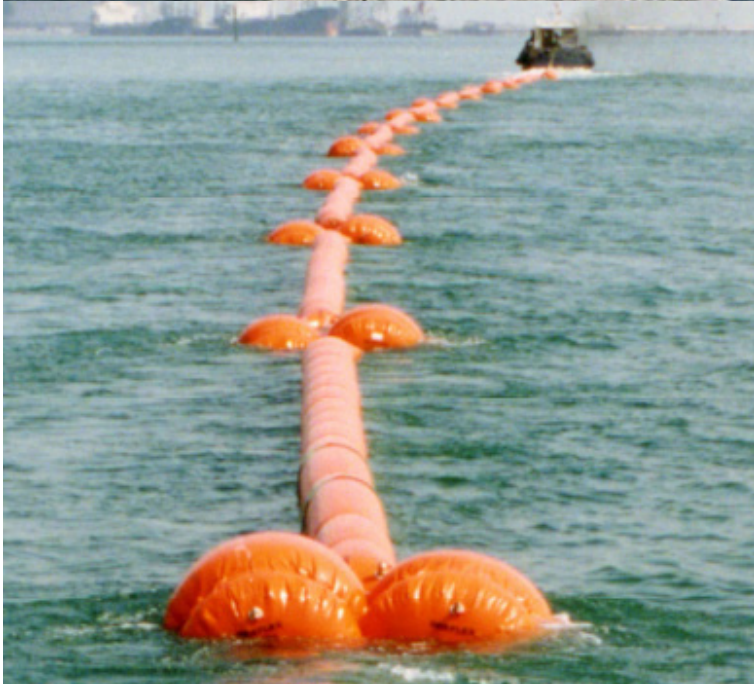

RANGE OVERVIEW

Seaflex Kraken™ for Pipelines Overview



# Seaflex Kraken™ for Pipelines Overview

## Introduction

### Introduction

+ Seaflex Kraken™ is designed to provide temporary buoyancy for the launch and installation of shallow water pipes and for supporting lengthy sections during surface or bottom tows. From a beach launch, the equipment can take up the pipe weight in very shallow water and, with a suitable air supply, provide buoyancy at any depth. It is particularly suited to ultra-shallow applications such as the floating of pipeline through swamps, where its low profile will ensure minimum draft throughout the operation.

### Description of Seaflex Kraken™

+ The patented Kraken™ buoyancy system consists of our heaviest weight PVC coated polyester fabric tube with high frequency (HF) welded seams and mechanically fitted penetrators with location loops spaced at 1.33m pitch along the crown of the unit. Various sizes are available, depending upon the amount of buoyancy required per metre to support the pipeline – generally working off a 2:1 reserve ratio against the actual weight in water of the pipeline. By fixing this buoyancy tube to a pipe with webbing stop or banding at 1.3m intervals, a continuous buoyancy is applied which produces very low stresses in the pipe.

The coated fabric tube is extremely strong and made by the world's leading performance fabric manufacturers. It has a proven record spanning 20 years and is an ideal material for underwater air filled buoyancy.



HIDD Pipeline, Bahrain, supported by Seaflex Kraken™ type 2650/2/13

### Benefits of Seaflex Kraken™

#### + Power to weight ratio

In round numbers, 10kg of packed flexible buoyancy will produce 1000kg of lift when inflated. A ratio of 100:1. No other type of buoyancy can come anywhere near this ratio.

#### + Cost per ton

On a per-ton of buoyancy basis, Kraken will be the cheapest form of inflatable buoyancy, when compared with individual buoyancy units such as Seaflex's MBUs and IBUs, and will be considerably lower than the cost of fabricating steel units or purchasing foam-filled plastic units. As a rough rule of thumb, solid buoyancy filled with foam designated at or near the surface will cost approximately GBP 1000 / USD 1500 per ton to purchase, whereas Kraken™ can be expected to come in at less than half that cost – and depending upon the size can be as little as a third of the cost of solid buoyancy.

When this is combined with the massively reduced shipping volume, the overall cost benefit of choosing Seaflex flexible buoyancy becomes extremely compelling.



Kraken™ fitted to the Chergui Pipeline, Tunisia, for Petrofac

#### + Control

By venting air, buoyancy can be removed by remote control from the surface; an ability that can be exploited to huge commercial effect. The advantage of being able to place the pipe on the bottom when positioned correctly after the tow, gently and without underwater intervention, is a major advantage over conventional forms of rigid buoyancy.



**Unique Group**

E. [buoyancyballast@uniquegroup.com](mailto:buoyancyballast@uniquegroup.com)

W. [www.uniquegroup.com](http://www.uniquegroup.com)

# Seaflex Kraken™ for Pipelines Overview

## Benefits Continued

### + Kind to Pipes

Because the Kraken™ buoyancy is uniform along the pipe and each attachment is carrying a light load, the forces exerted on the pipe are small and point loads are eliminated. The light weight is also helpful when fixing the buoyancy before launching as it exerts negligible rotational forces on the pipe before immersion.

### + Suited to ultra-shallow work

Initially designed for a project in a swamp, because of its continuous nature Kraken™ need not be of that big a diameter to offer a large amount of buoyancy through its entire length. This, combined with the fact that it is secured directly onto the top of the pipeline, makes it very probably the most efficient product in the market to float pipelines through ultra-shallow water.

### + Perfect for pulling and towing

While individual buoyancy units are ideal for the type of work where the pipe is only moving at a few metres per hour and they can be topped up from a floating airline, they are not so suited to a 'fast tow' with their large frontal area and individual air lines.

By using long tube Kraken™, individual air supply lines are reduced to manageable numbers and frontal area almost eliminated.

### + Robust and resistant

The fabric is extremely strong, and coated both inside and out, however chafe should be avoided to maintain the airtight integrity and structural strength of the fabric. It can withstand large impacts from blunt objects but continual movement on a single point, particularly a creased seam when folded, will erode the outer coating and eventually the basecloth. The outside coating is not critical as most of the air retention is performed by the inner coating; however chafing through the basecloth should be avoided.

Much of our equipment is used in contact with the sides of rusty and heavily encrusted wrecks, and for these short periods the fabric withstands attack from rough metal and crustaceans very well.

In practical terms, particularly with the Kraken, chafe problems can be reduced or eliminated by design of the attachments, use of chafe barriers (barriers as simple as sections of carpet have been used in the past) and proper handling procedures during attachment and removal.



More Images from Hidd Project, Bahrain



# Is Seaflex Kraken™ Suitable For My Project?

Perhaps. Ultimate suitability will depend upon factors such as the following:

## Are you floating the pipe or pulling it along the bottom?

- + If you are pulling it along the bottom, Kraken offers 545kg/m, so this solution will not be suitable for pipelines weighing more than around 300kg/m.

## How much buoyancy per metre will you require?

- + The largest size of Kraken offers 545kg/m, so will not be suitable if more than 300kg/m of buoyancy is required.

## How deep will the Kraken need to operate at?

- + Hoop Stress dictates that the smaller the Kraken the greater the depth that it will be able to operate at. The table underneath provides the main Kraken sizes, buoyancy and maximum depth rating.

But it is at the shallower end of the depth scale where the low-profile of the Kraken makes it most advantageous to users.

## Do you wish to purchase or hire buoyancy for this project?

- + Much of Seaflex's work with contractors installing pipelines is of a rental nature and makes use of individual buoyancy units such as our IBUs and MBUs rather than a continuous system such as Kraken. The reason for this is the versatility of individual units in that four sizes, 1t, 2t, 3t & 5t units are able to cope with any weight of pipe by varying the distance between units. From a hirer's point of view, we are only able to stock our massive tonnage of buoyancy for hire because this versatility ensures a reasonable usage rate.

So if your preference is to hire, then IBUs or MBUs are the way forward, whereas if your preference is to purchase and you are looking at a long float out in ultra-shallow water then Kraken is the best product for the job.

## Seaflex Kraken Specifications

Type	Lay Flat Width on Drum (mm)	Inflated OD Afloat (mm)	Buoyancy Kg/m	Weight / 50m Section (Kg)	Nominal Max Working Depth
2650-1-6	1305	830	545	222	12 msw
2650-2-10	655	430	132	76	20 msw
1500-1-18	730	465	170	85	22 msw

\* The maximum working depth is based on a reserve buoyancy factor (RF) of 50% and a 3:1 Factor of Safety on the working pressure.



**Unique Group**

E. [buoyancyballast@uniquegroup.com](mailto:buoyancyballast@uniquegroup.com)  
 W. [www.uniquegroup.com](http://www.uniquegroup.com)

# Seaflex Kraken™ for Pipelines Overview

## Diagrams

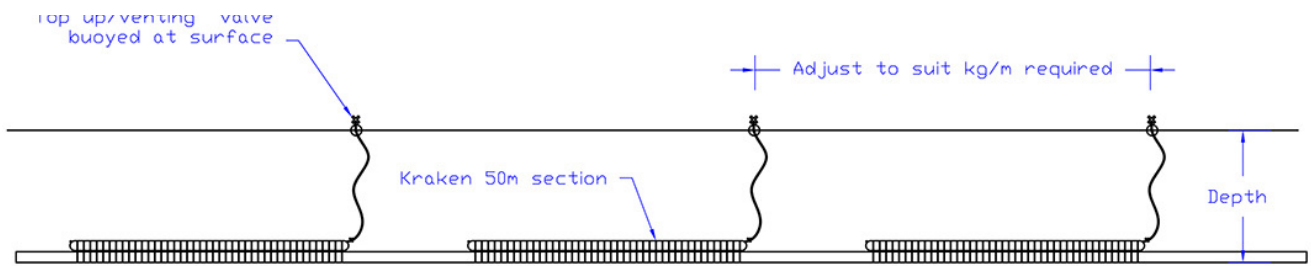

Vertical scale extended on view above

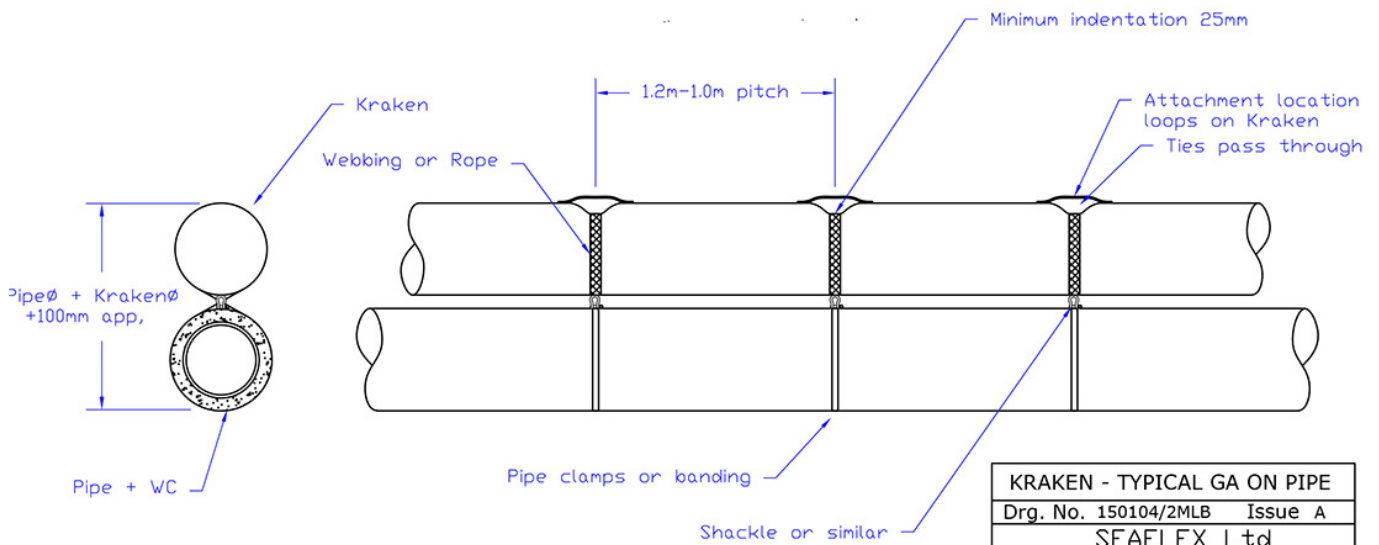

KRAKEN - TYPICAL GA ON PIPE	
Drg. No. 150104/2MLB	Issue A
SEAFLEX Ltd	
SAMUEL WHITES, COWES, ENGLAND, PO31 7RA.	
TEL: +441 983 290 525 FAX: +441 983 2905 853	



**Unique Group**

E. [buoyancyballast@uniquegroup.com](mailto:buoyancyballast@uniquegroup.com)  
 W. [www.uniquegroup.com](http://www.uniquegroup.com)

# Seaflex Kraken™ for Pipelines Overview

## Diagrams

### SEAFLEX KRAKEN PIPE BUOYANCY SYSTEM - SURFACE TOW GA

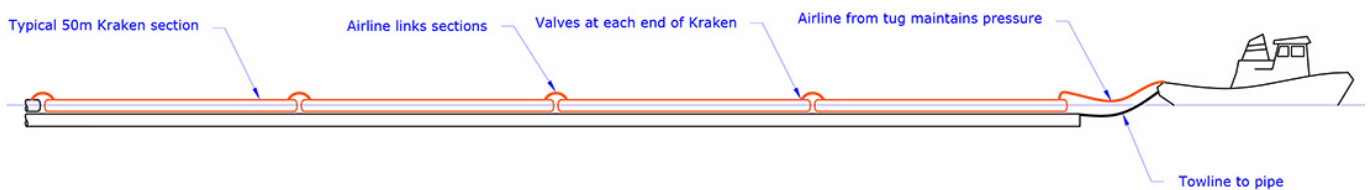

### TYPICAL ATTACHEMENT METHODS

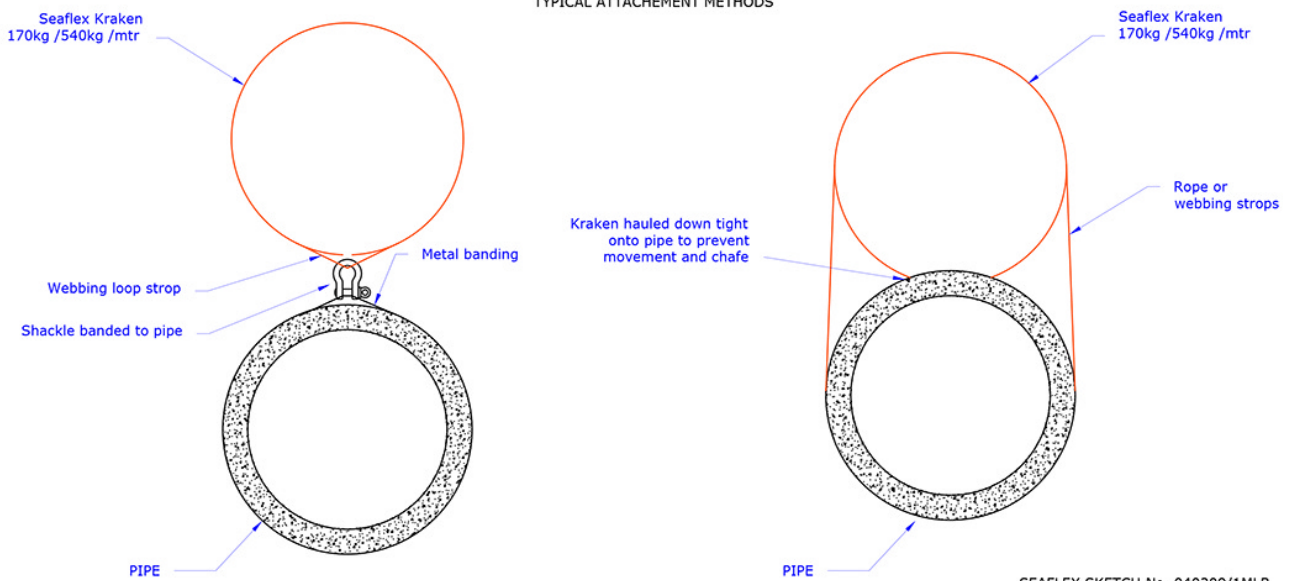

SEAFLEX SKETCH No. 040209/1MLB  
SCHEMATIC - DO NOT SCALE



Unique Group

E. [buoyancyballast@uniquegroup.com](mailto:buoyancyballast@uniquegroup.com)  
W. [www.uniquegroup.com](http://www.uniquegroup.com)

# Technology, Service and Support

## Manufacturing Technology

+ All Seaflex products are designed and manufactured in the UK. Our bag canopies are constructed from High Tensile Trevira® Polyester base cloth (either 2 /2 or 3 /3 fibre panama pattern weave) coated with heavy duty UV stabilised PVC coating or, for special applications, polyurethane. Trevira is incredibly strong; a 50 mm wide 3/3 strip has a break load of approximately 1 tonne. The panels for our bags are precision cut on our 15 metre long, 3 metre wide advanced automated table for perfect repeatability. Once inspected and approved panels are assembled by skilled personnel to using Radio Frequency welding to strict quality control standards.

## Certification

+ All our work is carried out within a system which complies with the ISO 9001-2009 Quality Management Standard as audited by Lloyds Register Quality Assurance for full traceability – and we have now gained ISO 14001 and ISO 18001 accreditation.

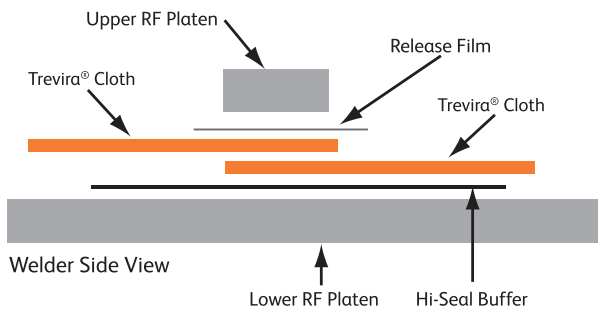
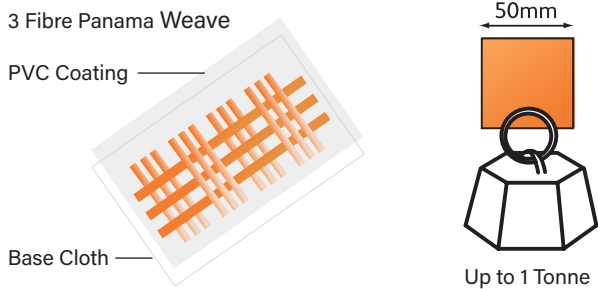

## Service

+ Whether for hire or sale, all Seaflex products are sent out fully tested and inspected against their build criteria. And we do also offer on-site support to our clients in the use of our products – this most often happens within the more complex buoyancy applications for our products.

In the event that your Seaflex product should suffer minor damage in service, we can supply an approved, boxed field service kit comprising of patches, a professional quality heat gun and instruction manual to make good minor leaks prior to product refurbishment.

We can also advise on the viability of carrying out more extensive repairs, which would typically be undertaken either at our factory or at one of our approved service centres.

## Support

+ Our support philosophy is "Wherever, Whenever". This underlines the Seaflex commitment to not just sending out tested, proven products in proper shipping crates and with the most comprehensive documentation package in the business – but to assisting our customers in every way possible throughout their time using our products, whether the job is a hire project or an equipment sale.

We offer worldwide support to our customers via either email or phone from head office in the UK and via our ever-growing network of offices and partners around the world.

You can put your trust in Seaflex – we won't let you down.



E. [buoyancyballast@uniquegroup.com](mailto:buoyancyballast@uniquegroup.com)  
W. [www.uniquegroup.com](http://www.uniquegroup.com)



Local presence  
worldwide

### UNIQUE GROUP OFFICES

#### MIDDLE EAST

##### UAE

Unique Group FZC  
Sharjah  
T. +971 6 5130333  
E. uaesales@uniquegroup.com

##### QATAR

Unique System Tr & Eng WLL  
Doha  
T. +974 44147079  
E. qatarsales@uniquegroup.com

##### SAUDI ARABIA

Muraba Alsahra Trading LLC  
Riyadh and Al Khobar  
T. +966 13 802 0614  
E. ksasales@uniquegroup.com

#### ASIA PACIFIC

##### SINGAPORE

Unique System (SEA) Pte Ltd  
Singapore  
T. +65 6542 1800  
E. fareastsales@uniquegroup.com

##### INDIA

Unique Hydrographic Systems Pvt Ltd  
Navi Mumbai and Vadodara  
T. +91 22 27619939/40/41/75  
E. indiasales@uniquegroup.com

#### AUSTRALIA

##### PERTH

Unique Subsea Australia Pty Ltd  
Perth Airport Park  
T. +61 418 205 212  
E. aussales@uniquegroup.com

##### QUEENSLAND

Unique Subsea Australia Pty Ltd  
Pinkenba, Queensland  
T. +61 418 205 212  
E. aussales@uniquegroup.com

#### USA

##### CENTRAL

Unique System Inc  
Houston, Texas  
T. +1 713 937 6193  
E. usasales@uniquegroup.com

##### EAST COAST

Water Weights Inc  
Suwanee, Georgia  
T. +1 678 730 4180  
E. buoyancyballast@uniquegroup.com

##### WEST COAST

Water Weights Inc  
Montclair, California  
T. +1 909 626 8316  
E. buoyancyballast@uniquegroup.com

#### AFRICA

##### SOUTH AFRICA

Unique Hydra (Pty) Ltd  
Cape Town  
T. +27 21 835 7900  
E. sasales@uniquegroup.com

##### NIGERIA

Unique Charkin System Ltd  
Port Harcourt  
T. +234 908 5659444  
E. nigeriasales@uniquegroup.com

#### EUROPE

##### UK

Unique Seaflex Ltd  
Cowes, Isle of Wight  
T. +44 1983 290 525  
E. buoyancyballast@uniquegroup.com

##### Unique System (UK) Ltd

Water Weights Ltd  
Aberdeen, Scotland  
T. +44 1224 723 742  
E. uksales@uniquegroup.com

##### NETHERLANDS

Unique System BV  
T. +31 850 513 700  
Water Weights BV  
T. +31 850 513 750  
Werkendam  
E. info.wwnl@uniquegroup.com

Unique Group's Buoyancy & Ballast products are available for hire or purchase from more than 20 other worldwide locations via our network of independent partners. Please contact us for more details.